

Kalderon

ARTIST-MADE TABLEWARE





TABLE OF CONTENTS

About P. 04

Multi-venue care P. 06

Exceptional designs P. 08-33

Extensive product selection P. 34

Plates P. 36-39

Bowls P. 40-43

Platters P. 44-48

Minis P. 49-51

Stands P. 52-57

Ample color options P. 58

Our values P. 59

All rights, including copyrights, design and industrial design rights, are reserved and the sole property of the artist and designer Dan Kalderon. All copying, distribution or use for private, commercial, or other use, is strictly prohibited without prior written authorization from Kalderon.

ABOUT

Kalderon is a glassware company that has been creating unique handmade tableware since 1995.

Dan Kalderon, the artist behind Kalderon's avant-garde designs, began his career as an award-winning, second generation, ceramics artist, before he has fallen in love with glass.

His passion and devotion to the challenging, yet exciting material, is evident in the glassware art he has been creating since.

Over the years, the Company, led by Dan and Michal Kalderon, positioned itself as a reference point for anyone seeking to obtain the perfect tabletop presentation, bestowing infinite creativity and striking appearance.

Kalderon's luxuriant product offering and remarkable customization capabilities are matched by high quality service and logistics support, that ensure an end-to-end outstanding experience.

Today, handcrafted dinnerware and buffetware by Kalderon are acquired by Michelin-star chefs and restaurants, luxury hotels and other high-end establishments in the global hospitality industry.

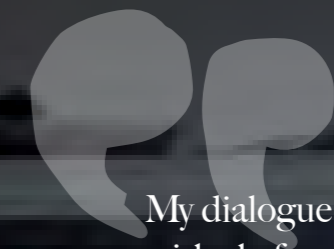
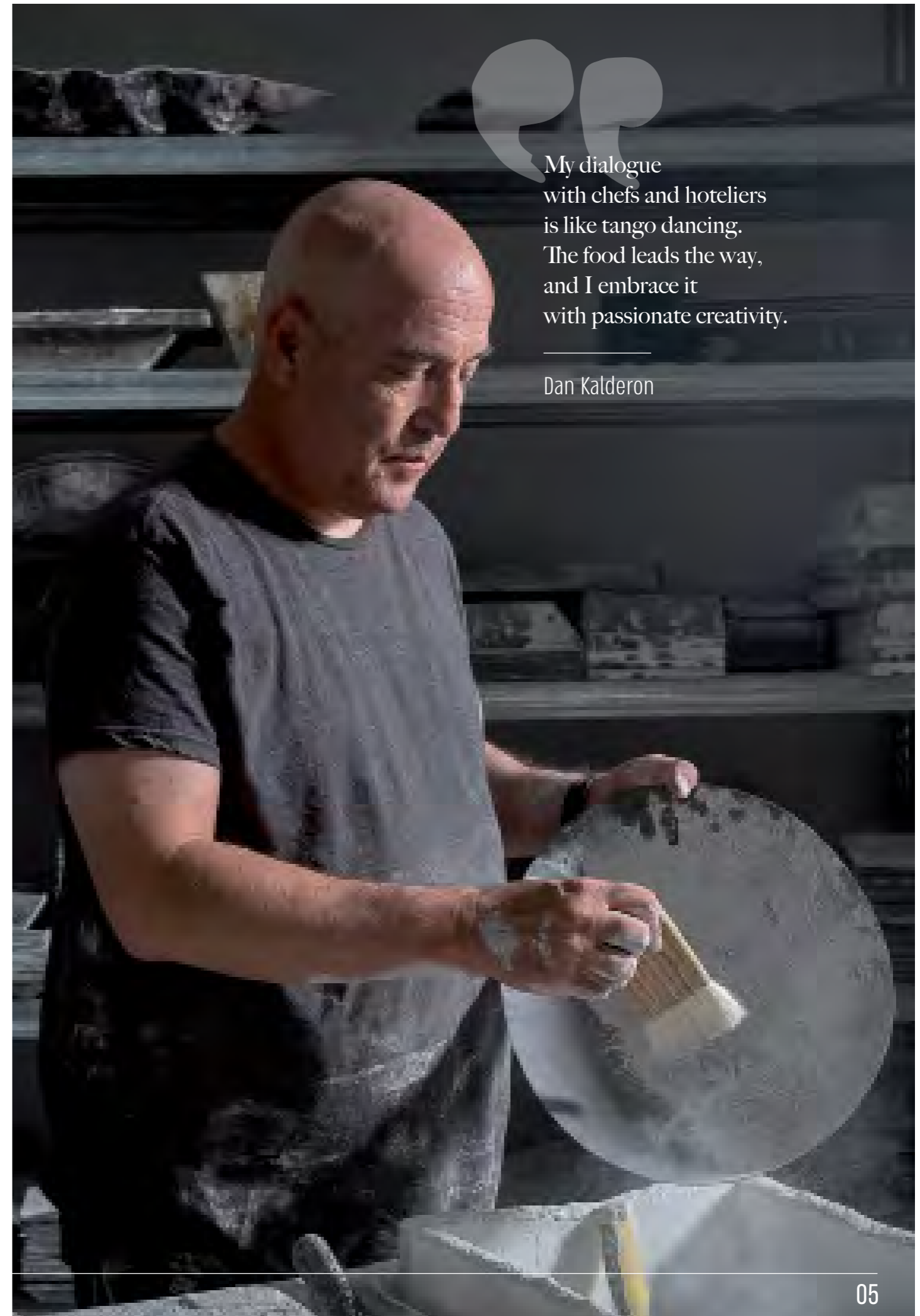
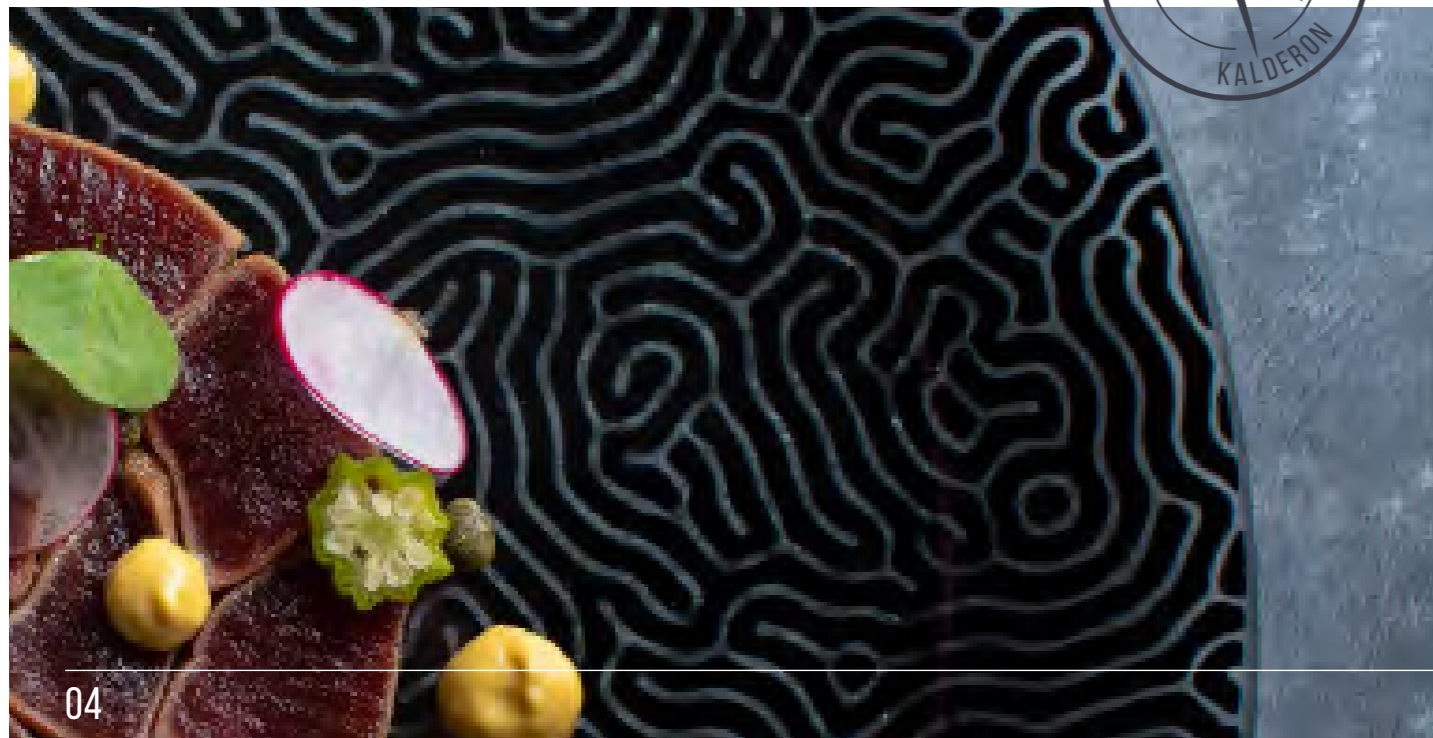

My dialogue with chefs and hoteliers is like tango dancing. The food leads the way, and I embrace it with passionate creativity.

Dan Kalderon

MULTI-VENUE CARE

An all-inclusive product offering in both functionality and appearance, coupled with bespoke solutions, allow Kalderon to successfully attend to the needs of any setting in the hospitality realm.



LOBBY

BATHROOM

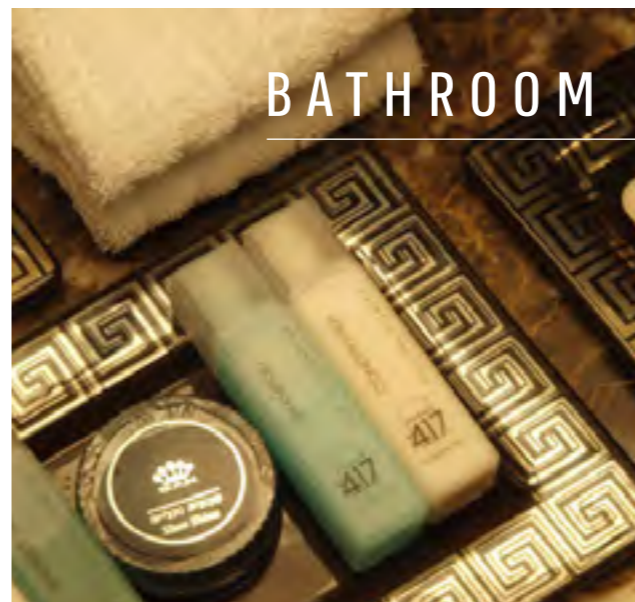

ROOM SERVICE



HIGH TEA



BUSINESS LOUNGE



BUFFET



ROOM COMPLIMENTARY

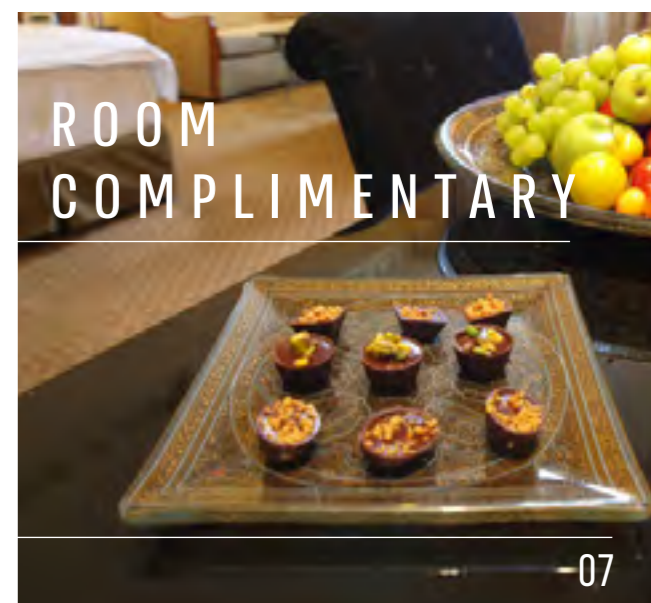

EXCEPTIONAL DESIGNS

Kalderon's remarkable artwork and texture collections, support hospitality visionaries' quest to reach for the stars and create memorable culinary experiences.



POMEGRANATE

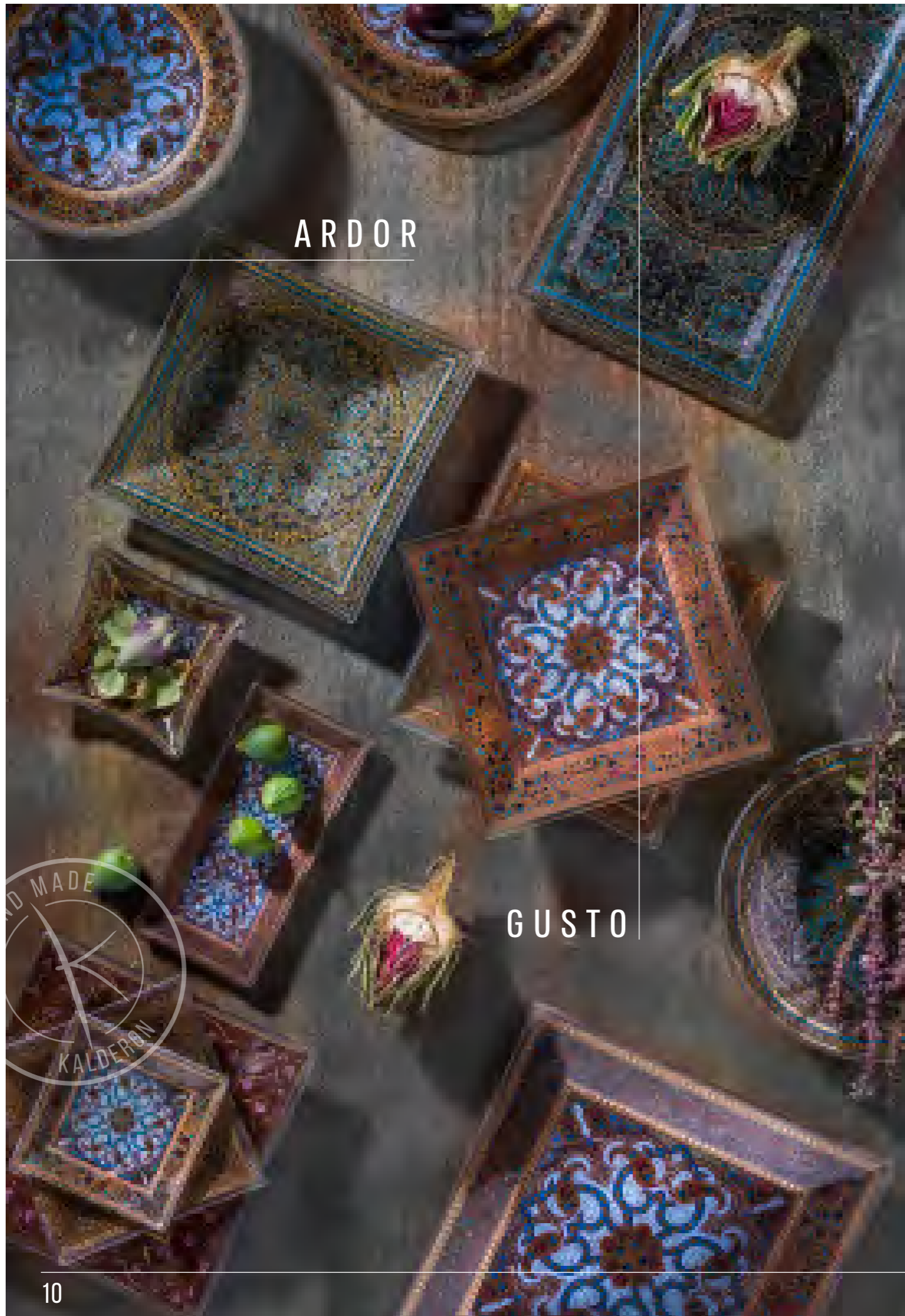

ARDOR

GUSTO

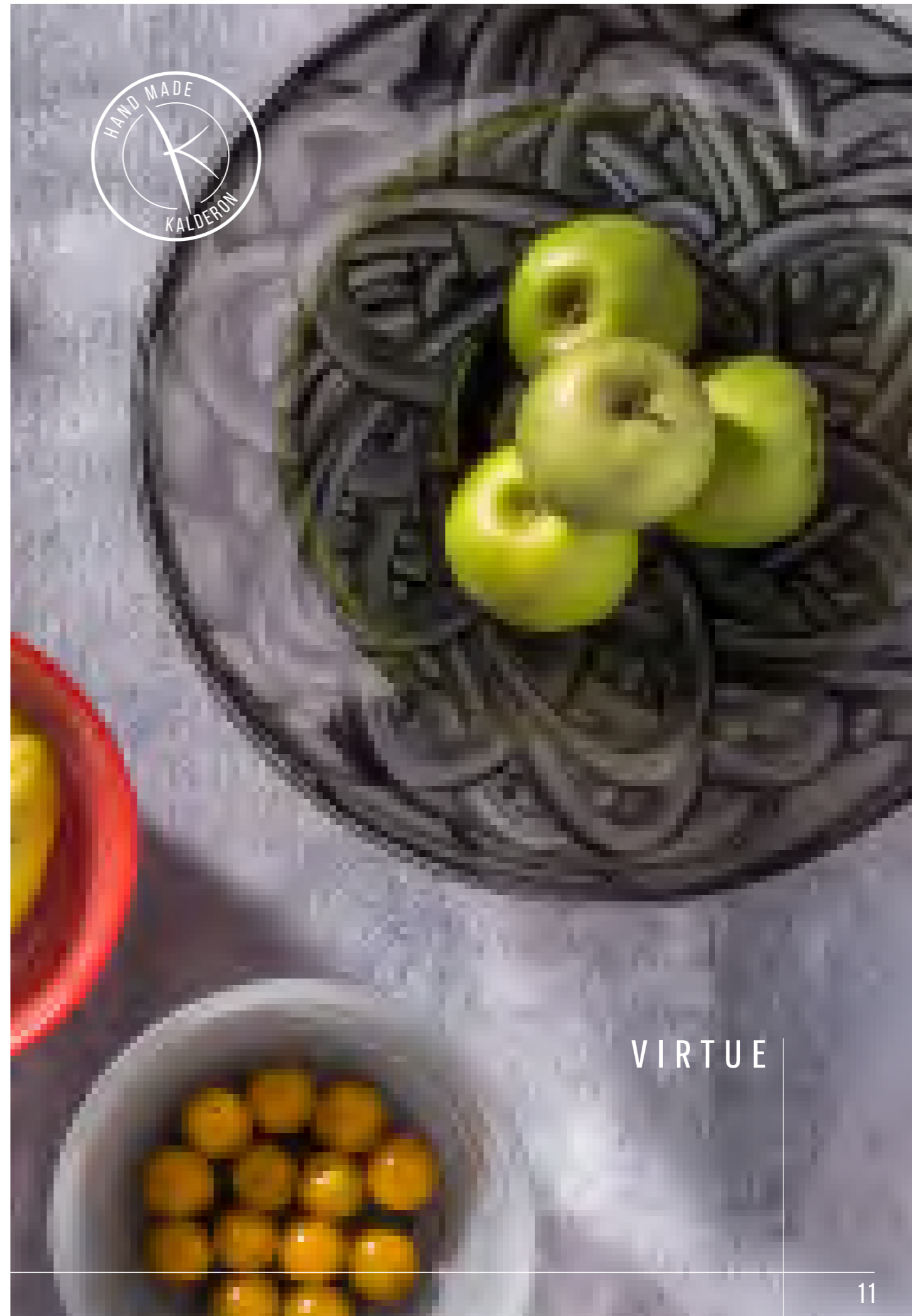

VIRTUE



LUSH



ZENITH



MIRAGE



HIVE J



HIVE Q



CORAL



ANGLE HAIR



SAHARA



SPHERE

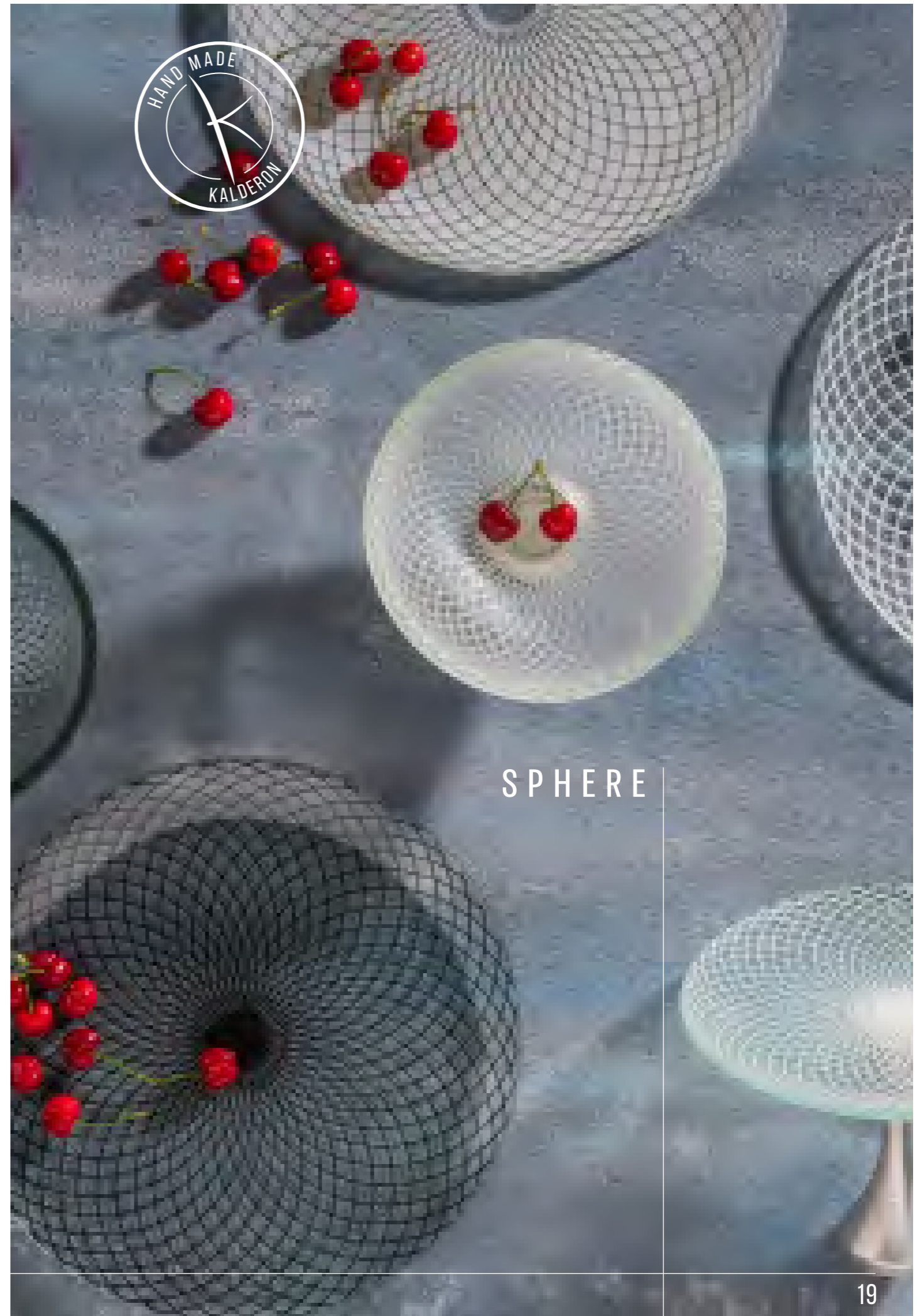

STIPULES



TIPI





INFINITE

SPLENDOR



IMPERIAL



HERITAGE





EARTH



PETAL





QUILL

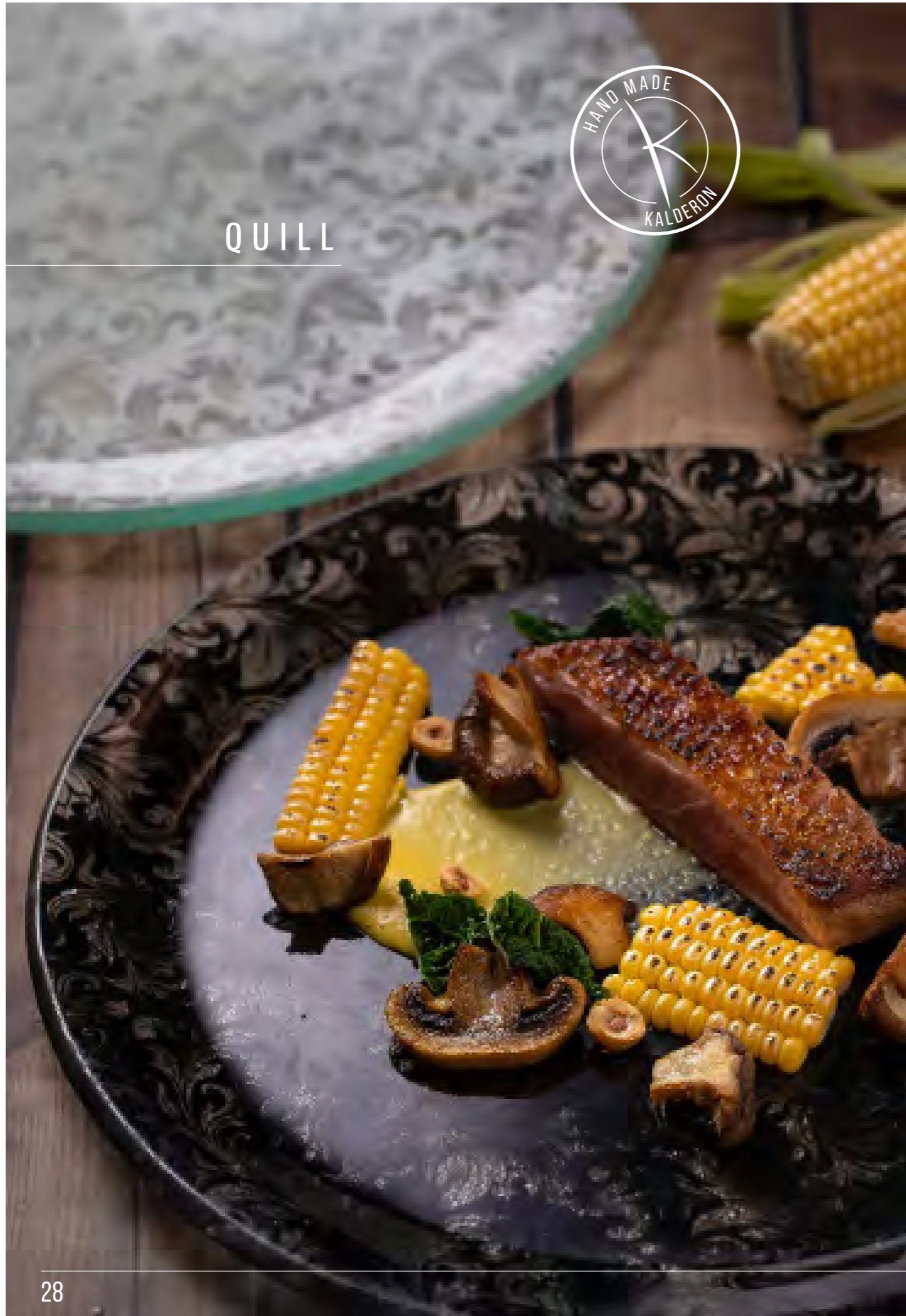

SPLASH





GALE



SANSUI



LATTICE



PHASE

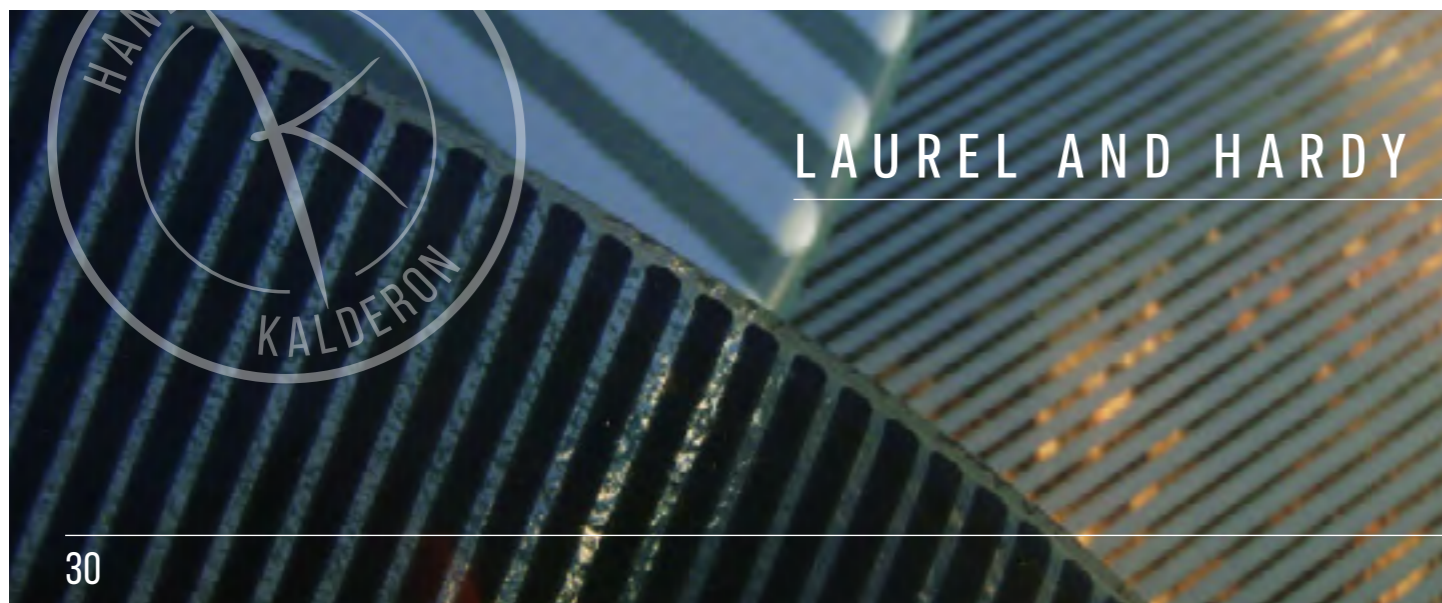

LAUREL AND HARDY



SLIVER

* APPLICABLE TO DEEP BOWLS

LUNAR



CROCHET



MASONRY



PEARLS



* APPLICABLE TO FLAT PLATES AND PLATTERS

EXTENSIVE PRODUCT SELECTION

Kalderon's carefully selected product mix and wide product range are key factors in the Company's endeavors to provide the best support to its customers.

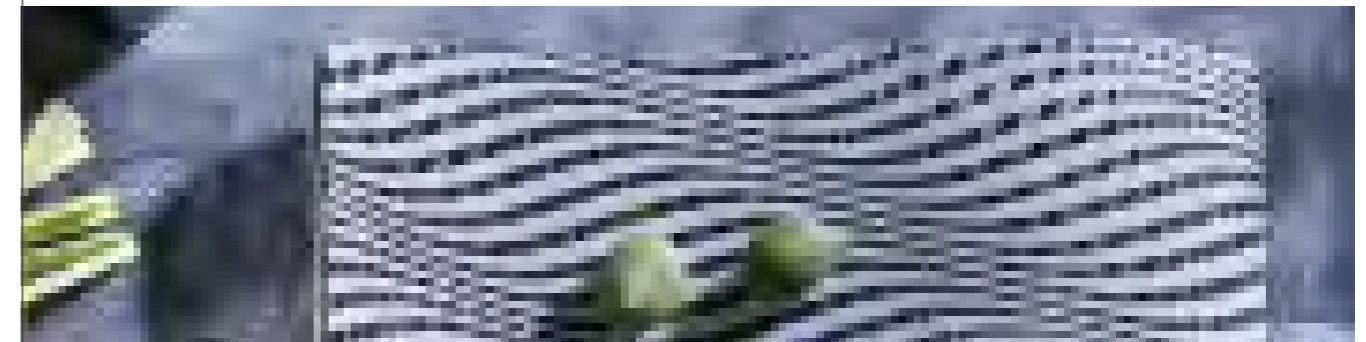

PRODUCT LINES

Plates P. 36-39

Bowls P. 40-43

Platters P. 44-48

Minis P. 49-51

Stands P. 52-57

Products are handmade.

Actual size may slightly differ from specified dimensions.

All dimensions, unless otherwise specified, refer to maximum external dimensions.

Bowls' height may vary by 8-10 mm | 0.3-0.4".

Glass thickness may vary upon type of use.

Recommended glass thickness is 8-10 mm | 0.3-0.4" for larger items, and 5-6 mm | 0.2" for smaller ones.



PLATES

PLATES



Round plate with moderate rim

Code	External Dimensions	
30048	Ø48X2.5 CM	Ø18.9X1"
30040	Ø40X2.5 CM	Ø15.7X1"
30035	Ø35X1.5 CM	Ø13.8X0.6"
30033	Ø33X1.5 CM	Ø13X0.6"
30030	Ø30X1.5 CM	Ø11.8X0.6"
30025	Ø25X1.5 CM	Ø9.8X0.6"
30020	Ø20X1.5 CM	Ø7.9X0.6"
30018	Ø18X1.5 CM	Ø7.1X0.6"
30016	Ø16X1.5 CM	Ø6.3X0.6"
30015	Ø15X1.5 CM	Ø5.9X0.6"



Round deep plate

Code	External Dimensions	
31050	Ø50X5 CM	Ø19.7X2"
31042	Ø42X4.5 CM	Ø16.5X1.8"
31036	Ø36X5 CM	Ø14.2X2"
31029	Ø29X3 CM	Ø11.4X1.2"
31026	Ø26X3 CM	Ø10.2X1.2"
31022	Ø22X3 CM	Ø8.7X1.2"
31018	Ø18X3 CM	Ø7.1X1.2"
31016	Ø16X3 CM	Ø6.3X1.2"
31013	Ø13X3 CM	Ø5.1X1.2"

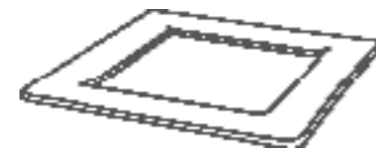

Square plate with wide rim

Code	External Dimensions		Internal Dimensions	
59030	30X30X1.5 CM	11.8X11.8X0.6"	21X21 CM	8.3X8.3"
59025	25X25X1.5 CM	9.8X9.8X0.6"	15X15 CM	5.9X5.9"
59019	19X19X1.5 CM	7.5X7.5X0.6"	11X11 CM	4.3X4.3"
59014	14X14X1.5 CM	5.5X5.5X0.6"	9X9 CM	3.5X3.5"

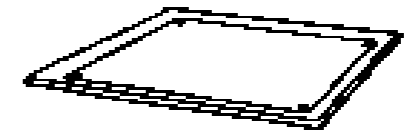

Square plate with slanted rim

Code	External Dimensions	
58030	30X30X1.5 CM	11.8X11.8X0.6"
58024	24X24X1.5 CM	9.4X9.4X0.6"
58019	19X19X1.5 CM	7.5X7.5X0.6"
58015	15X15X1.5 CM	5.9X5.9X0.6"

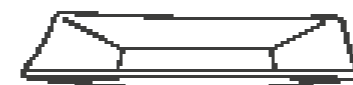

Square plate with conical rim

Code	External Dimensions	
53040	40X40X3 CM	15.7X15.7X1.2"
53035	35X35X2.5 CM	13.8X13.8X1"
53030	30X30X2 CM	11.8X11.8X0.8"
53027	27X27X2 CM	10.6X10.6X0.8"
53022	22X22X2 CM	8.7X8.7X0.8"



Rectangular plate with slanted rim

Code	External Dimensions	
51182	18X28X3 CM	7.1X11X1.2"
68142	14X20X3 CM	5.5X7.9X1.2"
68131	13X18X3 CM	5.1X7.1X1.2"

PLATES

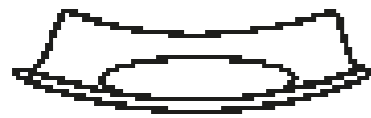

Curved square plate

Code	External Dimensions	
52040	40X40X3 CM	15.7X15.7X1.2"
52030	30X30X3 CM	11.8X11.8X1.2"
52027	27X27X3 CM	10.6X10.6X1.2"

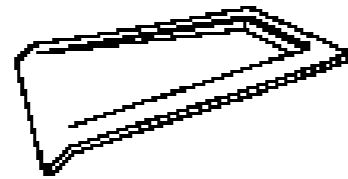

Slanted rectangular plate

Code	External Dimensions	
55223	22X35X2 CM	8.7X13.8X0.8"
55163	16X35X2 CM	6.3X13.8X0.8"
55162	16X25X2 CM	6.3X9.8X0.8"

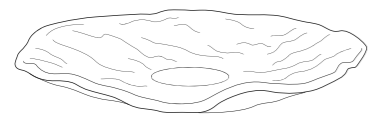

Round amorphous plate with lunar texture*

Code	External Dimensions	
32028	Ø28-30X4.5-6 CM	Ø11-11.8X1.8-2.4"

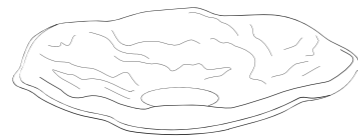

Round amorphous plate with lunar texture*

Code	External Dimensions	
32128	Ø28-30X4.5-6 CM	Ø11-11.8X1.8-2.4"

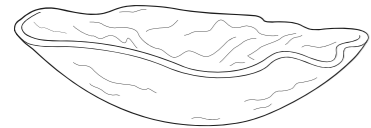

Round amorphous plate with lunar texture*

Code	External Dimensions	
32228	Ø28-30X5-7 CM	Ø11-11.8X2-2.8"



Round amorphous plate with lunar texture*

Code	External Dimensions	
32328	Ø28-30X4.5-6 CM	Ø11-11.8X1.8-2.4"

*Optional 4 cm | 1.6" high, stone-shaped leg

PLATES



Square origami plate

Code	External Dimensions	
21124	24X24X5 CM	9.4X9.4X2"



Round origami plate

Code	External Dimensions	
21224	Ø24X5 CM	Ø9.4X2"



Flower origami plate

Code	External Dimensions	
21324	Ø24X2.5 CM	Ø9.4X1"



Volcano origami plate

Code	External Dimensions	
21424	Ø24X4 CM	Ø9.4X1.6"



Blossom origami plate

Code	External Dimensions	
21637	Ø37X6 CM	Ø14.6X2.4"

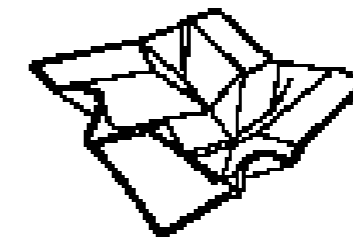

Petal-shaped origami plate

Code	External Dimensions	
21532	32X32X10 CM	12.6X12.6X3.9"



Caviar and condiments plate

Code	External Dimensions	
20024	21X42X4 CM	8.3X16.5X1.6"



BOWLS

BOWLS



Round bowl with amorphous rim

Code	External Dimensions	
16024	Ø24X7 CM	Ø9.4X2.8"
16020	Ø20X8 CM	Ø7.9X3.1"
16018	Ø18X6 CM	Ø7.1X2.4"
16016	Ø16X6 CM	Ø6.3X2.4"
16013	Ø13X6 CM	Ø5.1X2.4"



Round deep bowl with amorphous rim

Code	External Dimensions	
18034	Ø34X13 CM	Ø13.4X5.1"
18027	Ø27X10 CM	Ø10.6X3.9"



Round conical bowl with amorphous rim

Code	External Dimensions	
11032	Ø32X11 CM	Ø12.6X4.3"
11024	Ø24X11 CM	Ø9.4X4.3"
11020	Ø20X11 CM	Ø7.9X4.3"



Round conical bowl

Code	External Dimensions	
11014	Ø14X8.5 CM	Ø5.5X3.3"



Square conical deep bowl

Code	External Dimensions	
44028	28X28X11 CM	11X11X4.3"
44024	24X24X10.5 CM	9.4X9.4X4.1"
44021	21X21X10 CM	8.3X8.3X3.9"
44017	17X17X6.5 CM	6.7X6.7X2.6"



Flower-shaped conical deep bowl

Code	External Dimensions		Internal Base	
14332	Ø30X23 CM	Ø11.8X9.1"	Ø20 CM	Ø7.9"
14331	Ø30X13 CM	Ø11.8X5.1"	Ø25 CM	Ø9.8"
14322	Ø22X20 CM	Ø8.7X7.9"	Ø13 CM	Ø5.1"
14311	Ø17X15 CM	Ø6.7X5.9"	Ø11 CM	Ø4.3"

BOWLS

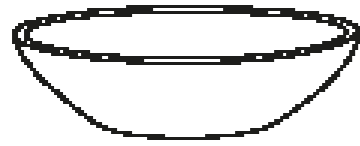

Round bowl

Code	External Dimensions	
12315	Ø31.5X7.5 CM	Ø12.4X3"
12275	Ø27.5X7 CM	Ø10.8X2.8"
12245	Ø24.5X7 CM	Ø9.6X2.8"



Round open bowl

Code	External Dimensions	
13057	Ø57X6 CM	Ø22.4X2.4"
13043	Ø43X7 CM	Ø16.9X2.8"
13039	Ø39X5.5 CM	Ø15.4X2.2"
13029	Ø29X3 CM	Ø11.4X1.2"

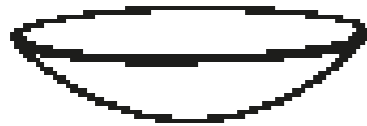

Round deep bowl

Code	External Dimensions	
14074	Ø74X12.5 CM	Ø29.1X4.9"
14052	Ø52X12 CM	Ø20.5X4.7"
14036	Ø36X9 CM	Ø14.2X3.5"
14028	Ø28X7 CM	Ø11X2.8"



Round conical open bowl

Code	External Dimensions	
17029	Ø29X6 CM	Ø11.4X2.4"



Square/rectangular deep bowl

Code	External Dimensions	
40027	27X27X9.5 CM	10.6X10.6X3.7"
40023	23X23X9.5 CM	9.1X9.1X3.7"
40215	21.5X21.5X5 CM	8.5X8.5X2"
40019	19X19X9.5 CM	7.5X7.5X3.7"
40213	21X32X9 CM	8.3X12.6X3.5"
40173	17X31X6 CM	6.7X12.2X2.4"



Square conical bowl

Code	External Dimensions	
42027	27X27X6 CM	10.6X10.6X2.4"
42023	23X23X5.5 CM	9.1X9.1X2.2"
42021	21X21X5.5 CM	8.3X8.3X2.2"
42018	18X18X5.5 CM	7.1X7.1X2.2"
42015	15X15X2 CM	5.9X5.9X0.8"

BOWLS



Hat-shaped round bowl

Code	External Dimensions		Internal Dimensions	
19031	Ø31X4.5 CM	Ø12.2X1.8"	Ø12 CM	Ø4.7"
19030	Ø30X6 CM	Ø11.8X2.4"	Ø12 CM	Ø4.7"
19025	Ø25X5 CM	Ø9.8X2"	Ø9.5 CM	Ø3.7"



Hat-shaped round bowl

Code	External Dimensions		Internal Dimensions	
15048	Ø48X6 CM	Ø18.9X2.4"	Ø24 CM	Ø9.4"
15039	Ø39X6 CM	Ø15.4X2.4"	Ø24 CM	Ø9.4"
15030	Ø30X4 CM	Ø11.8X1.6"	Ø21 CM	Ø8.3"
15021	Ø21X4 CM	Ø8.3X1.6"	Ø14 CM	Ø5.5"



Hat-shaped square bowl

Code	External Dimensions		Internal Dimensions	
47039	39X39X7 CM	15.4X15.4X2.8"	14X14 CM	5.5X5.5"
47035	35X35X5 CM	13.8X13.8X2"	14X14 CM	5.5X5.5"
47127	27X27X3 CM	10.6X10.6X1.2"	14X14 CM	5.5X5.5"



Square bowl with moderate rim

Code	External Dimensions		Internal Dimensions	
45039	39X39X6 CM	15.4X15.4X2.4"	30X30 CM	11.8X11.8"
45035	35X35X5 CM	13.8X13.8X2"	28X28 CM	11X11"
45031	31X31X3 CM	12.2X12.2X1.2"	23X23 CM	9.1X9.1"



PLATTERS

PLATTERS



Square platter with rim

Code	External Dimensions		Internal Dimensions	
54040	40X40X1.5 CM	15.7X15.7X0.6"	33X33 CM	13X13"
54035	35X35X1.5 CM	13.8X13.8X0.6"	28X28 CM	11X11"
54030	30X30X1.5 CM	11.8X11.8X0.6"	23X23 CM	9.1X9.1"
54025	25X25X1.5 CM	9.8X9.8X0.6"	19X19 CM	7.5X7.5"
54020	20X20X1.5 CM	7.9X7.9X0.6"	14X14 CM	5.5X5.5"



Rectangular platter with slanted rim

Code	External Dimensions	
80223	22X38X4 CM	8.7X15X1.6"
80235	23X53X7.5 CM	9.1X20.9X3"
80205	20X57X3 CM	7.9X22.4X1.2"
80245	20X45X3 CM	7.9X17.7X1.2"
80240	20X40X3 CM	7.9X15.7X1.2"

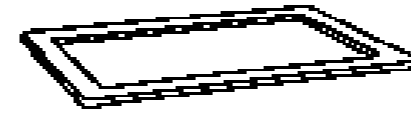

Rectangular platter with rim

Code	External Dimensions		Internal Dimensions	
71205	20X57X1.5 CM	7.9X22.4X0.6"	12X52 CM	4.7X20.5"
71304	30X45X1.5 CM	11.8X17.7X0.6"	12X32 CM	4.7X12.6"
71254	25X40X1.5 CM	9.8X15.7X0.6"	19X33 CM	7.5X13"
71204	20X40X1.5 CM	7.9X15.7X0.6"	12X32 CM	4.7X12.6"
71173	17X31X1.5 CM	6.7X12.2X0.6"	14X28 CM	5.5X11"



Rectangular platter with slanted rim

Code	External Dimensions	
73203	20X35X1.5 CM	7.9X13.8X0.6"
73163	16X35X1.5 CM	6.3X13.8X0.6"
73153	15X30X1.5 CM	5.9X11.8X0.6"
73127	16X27X1.5 CM	6.3X10.6X0.6"
73123	16X23X1.5 CM	6.3X9.1X0.6"
73122	12X25X1.5 CM	4.7X9.8X0.6"



Rectangular/square platter with slanted moderate rim

Code	External Dimensions	
81284	28X40X5.5 CM	11X15.7X2.2"
81303	30X30X5.5 CM	11.8X11.8X2.2"
81184	18X45X6 CM	7.1X17.7X2.4"
81145	14X52X5.5 CM	5.5X20.5X2.2"
81163	16X32X5.5 CM	6.3X12.6X2.2"
81143	14X35X5.5 CM	5.5X13.8X2.2"
81133	13X32X5.5 CM	5.1X12.6X2.2"



Rectangular platter with moderate rim

Code	External Dimensions	
84285	28X55X3 CM	11X21.7X1.2"
84244	24X41X3 CM	9.4X16.1X1.2"

PLATTERS



Elevated round platter with hidden legs

Code	External Dimensions	
82056	Ø56X7 CM	Ø22X2.8"
82027	Ø27X4 CM	Ø10.6X1.6"



Elevated rounded square platter with hidden legs

Code	External Dimensions	
82140	40X40X4 CM	15.7X15.7X1.6"



Elevated square platter with hidden legs

Code	External Dimensions	
82237	37X37X4 CM	14.6X14.6X1.6"
82227	27X27X4 CM	10.6X10.6X1.6"



Elevated triangle platter with hidden legs

Code	External Dimensions	
82344	46X46X8 CM	18.1X18.1X3.1"



Elevated oval platter with hidden legs

Code	External Dimensions	
82446	40X60X6 CM	15.7X23.6X2.4"



Elevated drop-shaped platter with hidden legs

Code	External Dimensions	
82536	30X60X5 CM	11.8X23.6X2"
82524	22X45X4 CM	8.7X17.7X1.6"



Elevated boat-like platter

Code	External Dimensions	
75268	26X89X2 CM	10.2X35X0.8"
75266	26X60X2 CM	10.2X23.6X0.8"

PLATTERS



Ocean waves platter

Code	External Dimensions	
87040	40X40X4 CM	15.7X15.7X1.6"
87030	30X30X3 CM	11.8X11.8X1.2"
87153	15X30X3 CM	5.9X11.8X1.2"

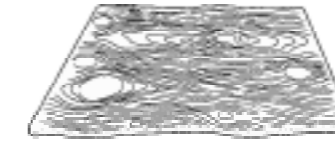

Wood-textured platter

Code	External Dimensions	
76032	32X32 CM	12.6X12.6"
76253	25X35 CM	9.8X13.8"



Wave platter

Code	External Dimensions	
78253	25X38X4 CM	9.8X15X1.6"

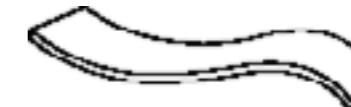

Wave platter

Code	External Dimensions	
78143	14X38X4 CM	5.5X15X1.6"



Pleated platter

Code	External Dimensions	
77264	26X45X2.5 CM	10.2X17.7X1"



Bridge platter

Code	External Dimensions	
72252	25X29X2.5 CM	9.8X11.4X1"



Open platter with slanted wide rims

Code	External Dimensions		Internal Dimensions	
88183	18X32X3 CM	7.1X12.6X1.2"	18X20 CM	7.1X7.9"

PLATTERS



3-compartment rectangular platter

Code	External Dimensions	Compartment Dimensions
86381	8X17X1 CM 3.1X6.7X0.4"	4X5 CM 1.6X2"



4-compartment square platter

Code	External Dimensions	Compartment Dimensions
86422	25X25X3 CM 9.8X9.8X1.2"	8.5X8.5 CM 3.3X3.3"



6-compartment rectangular platter

Code	External Dimensions	Compartment Dimensions
86612	18X24X3 CM 7.1X9.4X1.2"	5.5X5.5 CM 2.2X2.2"



8-compartment rectangular platter

Code	External Dimensions	Compartment Dimensions
86813	17X31X3 CM 6.7X12.2X1.2"	5.5X5.5 CM 2.2X2.2"



7-compartment palette platter

Code	External Dimensions	Compartment Dimensions
86734	35X41X1.5 CM 13.8X16.1X0.6"	Ø7.5 CM Ø3"

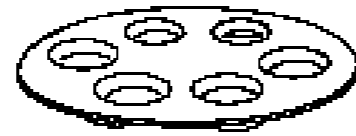

6-compartment round platter

Code	External Dimensions	Compartment Dimensions
86633	Ø31X3 CM Ø12.2X1.2"	Ø6 CM Ø2.4"



MINIS



MINIS



Mini square plate with rim

Code	External Dimensions	
66012	12X12X1.5 CM	4.7X4.7X0.6"
66010	10X10X1.5 CM	3.9X3.9X0.6"



Mini square plate with slanted rim

Code	External Dimensions	
65011	11X11X1.5 CM	4.3X4.3X0.6"
65095	9.5X9.5X1.5 CM	3.7X3.7X0.6"

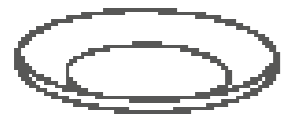

Mini round bowl with moderate rim

Code	External Dimensions	
62010	Ø10X1.5 CM	Ø3.9X0.6"



Mini conical square bowl

Code	External Dimensions	
60105	10.5X10.5X3.5 CM	4.1X4.1X1.4"
60008	8X8X3.5 CM	3.1X3.1X1.4"

MINIS



Mini round bowl

Code	External Dimensions	
63010	Ø10X3 CM	Ø3.9X1.2"



Mini round bowl with amorphous rim

Code	External Dimensions	
61008	Ø8X4.5 CM	Ø3.1X1.8"



Mini round bowl with amorphous rim

Code	External Dimensions	
69008	Ø8X2.5 CM	Ø3.1X1"



Mini round bowl with amorphous rim

Code	External Dimensions	
67007	Ø7X3 CM	Ø2.8X1.2"

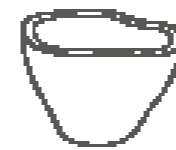

Mini round conical bowl with amorphous rim

Code	External Dimensions	
64008	Ø8X5-7 CM	Ø3.1X2-2.8"



Mini round bowl with amorphous rim

Code	External Dimensions	
16011	Ø11.5X5 CM	Ø4.5X2"



STANDS

STANDS

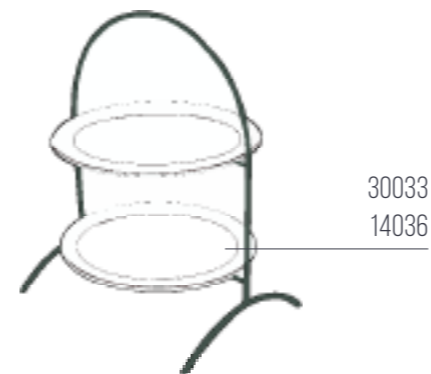

2-tiered metal stand with two round plates

Code	Max. External Dimensions
91244	41X41X47 CM 16.1X16.1X18.5"

Available Serving Dishes

Code	Dish External Dimensions
30033	Ø33 CM Ø13"
14036	Ø36 CM Ø14.2"

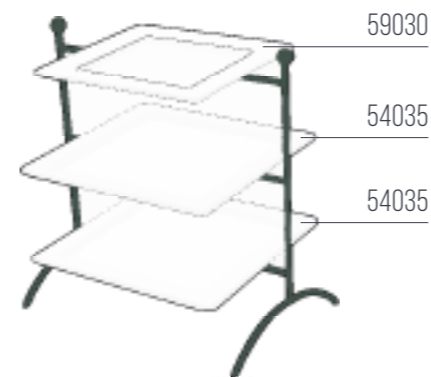

3-tiered metal stand with three square plates

Code	Max. External Dimensions
91333	39X35X38 CM 15.4X13.8X15"

Available Serving Dishes

Code	Dish External Dimensions
59030	30X30 CM 11.8X11.8"
54035	35X35 CM 13.8X13.8"

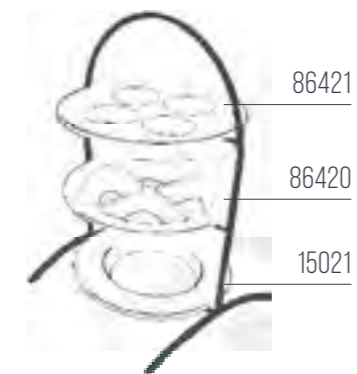

3-tiered metal stand with three deep plates

Code	Max. External Dimensions
91322	29X29X40 CM 11.4X11.4X15.7"

Available Serving Dishes

Code	Dish External Dimensions
86421	Ø21 CM Ø8.3"
86420	Ø21 CM Ø8.3"
15021	Ø21 CM Ø8.3"



3-tiered metal stand with three rectangular platters

Code	Max. External Dimensions
91323	29X40X60 CM 11.4X15.7X23.6"

Available Serving Dishes

Code	Dish External Dimensions
71254	25X40 CM 9.8X15.7"

ALL STANDS ARE AVAILABLE IN GALVANIZED, POWDER-COATED STEEL OR IN STAINLESS-STEEL

STANDS

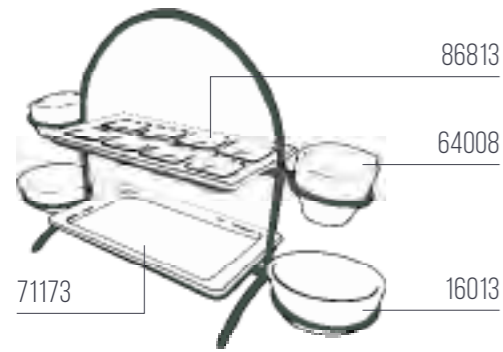

2-tiered metal stand with two rectangular platters

Code	Max. External Dimensions
91251	50X18X36 CM 19.7X7.1X14.2"

Available Serving Dishes

Code	Dish External Dimensions
86813	17X31 CM 6.7X12.2"
71173	17X31 CM 6.7X12.2"
64008	Ø8 CM Ø3.1"
16013	Ø13 CM Ø5.1"



3-level metal stand with three conical bowls

Code	Max. External Dimensions
92334	32X47X53 CM 12.6X18.5X20.9"

Available Serving Dishes

Code	Dish External Dimensions
44017	17X17X6.5 CM 6.7X6.7X2.6"
44021	21X21X10 CM 8.3X8.3X4"
44024	24X24X10.5 CM 9.5X9.5X4.1"



3-level metal stand with three rectangular platters

Code	Max. External Dimensions
92365	63X57X28 CM 24.8X22.4X11"

Available Serving Dishes

Code	Dish External Dimensions
80240	20X40 CM 7.9X15.7"
80245	20X45 CM 7.9X17.7"
80205	20X57 CM 7.9X22.4"



Trio metal stand with three rectangular platters

Code	Max. External Dimensions
92366	65X57X20 CM 25.6X22.4X7.9"

Available Serving Dishes

Code	Dish External Dimensions
80240	20X40 CM 7.9X15.7"
80245	20X45 CM 7.9X17.7"
80205	20X57 CM 7.9X22.4"

ALL STANDS ARE AVAILABLE IN GALVANIZED, POWDER-COATED STEEL OR IN STAINLESS-STEEL

STANDS

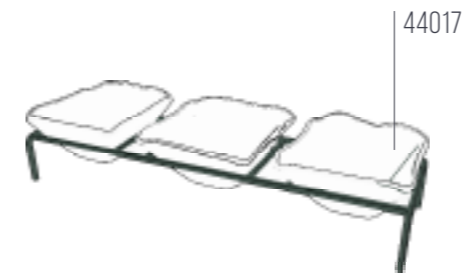

Metal stand with three conical bowls

Code	Max. External Dimensions
94351	53X19X11 CM 20.9X7.5X4.3"

Available Serving Dishes

Code	Dish External Dimensions
44017	17X17X6.5 CM 6.7X6.7X2.6"

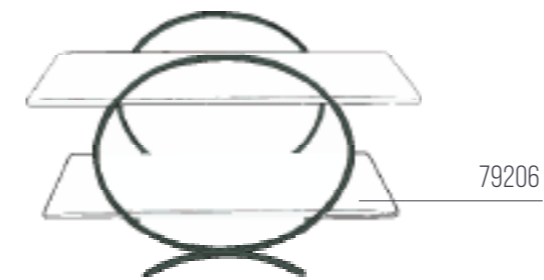

2-tiered metal stand with two flat rectangular platters

Code	Max. External Dimensions
91225	22X57X37 CM 8.7X22.4X14.6"

Available Serving Dishes

Code	Dish External Dimensions
79206	20X57 CM 7.9X22.4"



2-level metal stand with six conical bowls

Code	Max. External Dimensions
92253	54X37X20 CM 21.3X14.6X7.9"

Available Serving Dishes

Code	Dish External Dimensions
44017	17X17X6.5 CM 6.7X6.7X2.6"

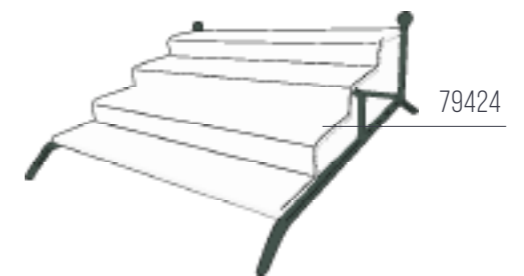

Metal stand with 4-level step-shaped platter

Code	Max. External Dimensions
92444	46X50X21 CM 18.1X19.7X8.3"

Available Serving Dishes

Code	Dish External Dimensions
79424	42X44 CM 16.5X17.3"

ALL STANDS ARE AVAILABLE IN GALVANIZED, POWDER-COATED STEEL OR IN STAINLESS-STEEL

STANDS

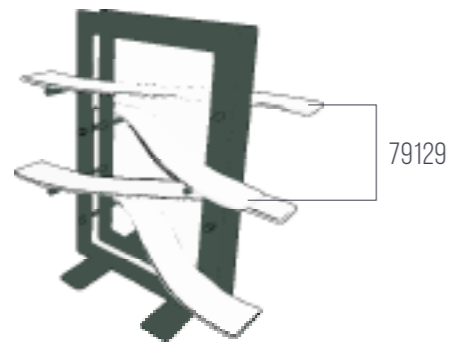

Multi-tiered metal stand with wave platters

Code	Max. External Dimensions
91249	40X95X90 CM 15.7X37.4X35.4"

Available Serving Dishes

Code	Dish External Dimensions
79129	12X95 CM 4.7X37.4" (RIGHT/LEFT SET)



Honeycomb metal stand with rectangular plate

Code	Max. External Dimensions
93043	30X49X60 CM 11.8X19.3X23.6"

Available Serving Dishes

Code	Dish External Dimensions
71304	30X45 CM 11.8X17.7"

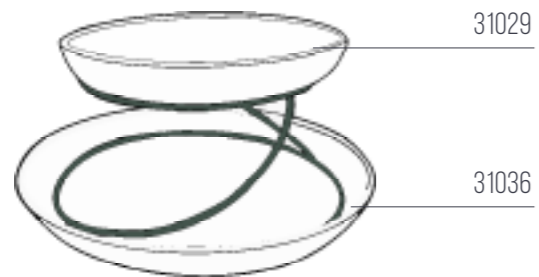

2-tiered metal sea food stand with two round deep plates

Code	Max. External Dimensions
91233	36X36X20 CM 14.2X14.2X7.9"

Available Serving Dishes

Code	Dish External Dimensions
31029	Ø29X3 CM Ø11.4X1.2"
31036	Ø36X5 CM Ø14.1X2"

ALL STANDS ARE AVAILABLE IN GALVANIZED, POWDER-COATED STEEL OR IN STAINLESS-STEEL



AMPLE COLOR OPTIONS

Kalderon's products are available in dozens of colors, from dreamy white and luscious cognac through edgy mustard and classic blue, to daring black and royal gold.

And the (blue) sky's the limit ...



OUR VALUES

WE MAKE ART

Passion drives us to create and design unique glassware concepts that translate into unforgettable experiences.

PARTNERSHIP

We engage in meaningful dialogues with our customers to select the best-suited products for their needs. Our service, like our handmade items, is characterized by a personal touch.

QUALITY

Our commitment to providing top quality glassware is manifested in the meticulous quality control review each of our handmade items undergoes.

FUNCTIONALITY

Our beautiful glassware is intended to perform in heavy-duty commercial settings. All of our products are highly durable, dishwasher and microwave* safe, stackable, and lead-and-cadmium free.

* Microwave safe: excluding metal-contained items

ENVIRONMENTAL

Our glassware items are produced with recycled glass and water, adhering to the highest environmental standards.



**THINK LIKE A DREAMER.
SELECT LIKE A DESIGNER.**

OFFICES, SHOWROOM AND PRODUCTION FACILITIES

Hanita, Western Galilee, Israel 2288500

Tel: +972-4-9823030

Fax: +972-153-4-9823030

Email: info@kalderonmd.com

www.kalderonmd.com

